



**SIMON OWNER'S MANUAL**



**simon**

TM

# FCC Notices

## FCC Part 15 Information to the User

Changes or modifications not expressly approved by Interlogix Inc. can void the user's authority to operate the equipment.

### FCC Part 15 Class B

This equipment has been tested and found to comply with the limits for a Class B digital device, pursuant to part 15 of the FCC Rules. These limits are designed to provide reasonable protection against interference in a residential installation.

This equipment generates, uses, and can radiate radio frequency energy and, if not installed and used in accordance with the instructions, may cause harmful interference to radio communications. However, there is no guarantee that interference will not occur in a particular installation.

If this equipment does cause harmful interference to radio or television reception, which can be determined by turning the equipment off and on, the user is encouraged to try to correct the interference by one or more of the following measures:

- Reorient or relocate the receiving antenna.
- Increase the separation between the equipment and receiver.
- Connect the affected equipment and the panel receiver to separate outlets, on different branch circuits.
- Consult the dealer or an experienced radio/TV technician for help.

FCC ID: B4Z-787E-SIMON

### ACTA Part 68

This equipment complies with Part 68 of the FCC Rules. Located on this equipment is a label that contains, among other information, the FCC registration number and the ringer equivalence number (REN) for this equipment. If requested, this information must be provided to the telephone company.

FCC Part 68 Registration No. B4ZUSA-27621-AL-E REN: 0.2B

The REN is used to determine the maximum number of devices that may be connected to your telephone line. Excessive RENs on a telephone line may result in devices not ringing in response to an incoming call. In most areas, the sum of all device RENs should not exceed five (5.0). To be certain of the number of devices that may be connected to a line, as determined by the total RENs, contact the local telephone company. For products approved after July 23, 2001, the REN for this product is part of the product identifier that has the format US:AAAEQ##TXXXX. The digits represented by ## are the REN without a decimal point (e.g., 03 is a REN of 0.3). For earlier products, the REN is separately shown on the label.

A plug and jack used to connect this equipment to the premises wiring and telephone network must comply with the applicable FCC Part 68 rules and requirements as adopted by ACTA. A compliant telephone cord and modular plug is provided with this product. It is designed to be connected to a compliant modular jack that is also compliant. See the Installation Instructions for details.

Alarm dialing equipment must be able to seize the telephone line and place a call in an emergency situation. It must be able to do this even if other equipment (telephone, answering system, computer modem, etc.) already has the telephone line in use. To do so, alarm dialing equipment must be connected to a properly installed RJ31X jack that is electrically in series and ahead of all other equipment attached to the same telephone line. Proper installation is depicted in the following diagram. If you have any questions concerning these instructions, consult your local telephone company or a qualified installer about installing an RJ31X jack and alarm dialing equipment for you.

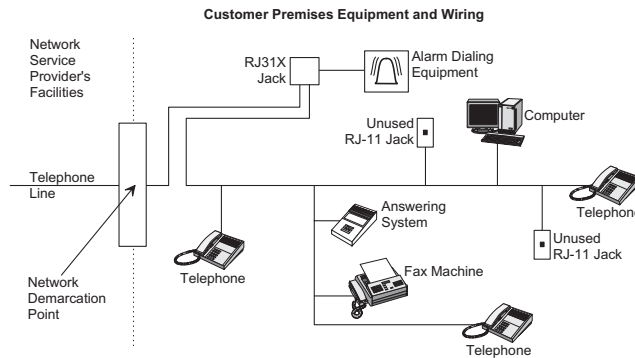

If this equipment causes harm to the telephone network, the telephone company may temporarily disconnect your service. If possible, you will be notified in advance. When advance notice is not practical, you will be notified as soon as possible. You will also be advised of your right to file a complaint with the FCC.

The telephone company may make changes in its facilities, equipment, operations, or procedures that could affect the operation of the equipment. You will be given advance notice in order to maintain uninterrupted service.

If you experience trouble with this equipment, please contact the company that installed the equipment for service and/or repair information. The telephone company may ask you to disconnect this equipment from the network until the problem has been corrected or you are sure that the equipment is not malfunctioning.

This equipment may not be used on coin service provided by the telephone company. Connection to party lines is subject to state tariffs.

## Canada Notice

The Canadian Department of Communications label identifies certified equipment. This certification means that the equipment meets certain telecommunications network protective, operational, and safety requirements. The department does not guarantee the equipment will operate to the user's satisfaction.

Before installing this equipment, users should ensure that it is permissible to be connected to the facilities of the local telecommunications company. The equipment must also be installed using an acceptable method of connection. In some cases, the company's inside wiring associated with a single-line individual service may be extended by means of a certified connector assembly (telephone extension cord). The customer should be aware that compliance with the above conditions may not prevent degradation of service in some situations.

Repairs to certified equipment should be made by an authorized Canadian maintenance facility designated by the supplier. Any repairs or alterations made by the user to this equipment, or equipment malfunctions, may give the telecommunications company cause to request the user to disconnect the equipment.

For your protection, make sure that the electrical ground connections of the power utility, telephone lines, and internal metallic water pipe system, if present, are connected together



**Caution**

**Do not attempt to make connections yourself. Contact the appropriate electrician or electric inspections authority.**

The Load Number (LN) assigned to each terminal device denotes the percentage of the total load to be connected to a telephone loop which is used by the device, to prevent overloading. The termination on a loop may consist of any combination of devices subject only to the requirement that the total of the LNs of all the devices does not exceed 100. Load Number: .1 *The term "IC:" before the certification/registration number only signifies that the Industry Canada technical specifications were met.* IC: 867A 787SIMON

“AVIS: - L'étiquette du ministère des Communications du Canada identifie le matériel homologué. Cette étiquette certifie que le matériel est conforme a certaines normes de protection, d'exploitation et de sécurité des réseaux de télécommunications. Le ministère n'assure toutefois pas que le matériel fonctionnera a la satisfaction de l'utilisateur.

Avant d'installer ce matériel, l'utilisateur doit s'assurer qu'il est permis de le raccorder aux installations de l'entreprise locale de télécommunication. Le matériel doit également être installé en suivant une méthode acceptée de raccordement. Dans certains cas, les fils intérieurs de l'entreprise utilisés pour un service individuel a ligne unique peuvent être prolongés au moyen d'un dispositif homologué de raccordement (cordon prolongateur téléphonique interne). L'abonné ne doit pas oublier qu'il est possible que la conformité aux conditions énoncées ci-dessus n'empêchent pas le dégradation du service dans certaines situations. Actuellement, les entreprises de télécommunication ne permettent pas que l'on raccorde leur matériel a des jacks d'abonné, sauf dans les cas précis prévus par les tarifs particuliers de ces entreprises.

Les réparations de matériel homologué doivent être effectuées par un centre d'entretien canadien autorisé désigné par le fournisseur. La compagnie de télécommunications peut demander a l'utilisateur de débrancher un appareil a la suite de réparations ou de modifications effectuées par l'utilisateur ou a cause de mauvais fonctionnement.

Pour sa propre protection, l'utilisateur doit s'assurer que tous les fils de mise a la terre de la source d'énergie électrique, des lignes téléphoniques et des canalisations d'eau métalliques, s'il y en a, sont raccordés ensemble. Cette précaution est particulièrement importante dans les régions rurales.

Avertissement. - L'utilisateur ne doit pas tenter de faire ces raccordements lui-même; il doit avoir recours a un service d'inspection des installations électriques, ou a un electricien, selon le cas”.

Une note explicative sur les indices de charge (voir 1.6) et leur emploi, a l'intention des utilisateurs du matériel terminal, doit être incluse dans l'information qui accompagne le matériel homologué. La note pourrait être rédigée selon le modèle suivant:

“L'indice de charge (IC) assigné a chaque dispositif terminal indique, pour éviter toute surcharge, le pourcentage de la charge totale qui peut être raccordée a un circuit téléphonique bouclé utilisé par ce dispositif. La terminaison du circuit bouclé peut être constituée de n'importe quelle somme des indices de charge de l'ensemble des dispositifs ne dépasse pas 100.”

L'Indice de charge de ce produit est \_\_\_\_\_.



**GE Interlogix**

---

© 2003 GE Interlogix. Simon is a trademark of GE Interlogix. All other trademarks are properties of their owners. For reprints, order document 466-1575 Rev. D

2266 Second Street North  
North Saint Paul MN 55109

All rights reserved.

# TABLE OF CONTENTS

Introduction .....	1
Security System Beeps, Lights, and Messages .....	3
How to Use Your Control Panel .....	5
How to Use Your Touchpads .....	8
Programming Your System .....	9
System Tests & Trouble Beeps .....	12
Your Emergency Evacuation Floor Plan .....	14
Alarm System Limitations .....	15
Index .....	16
Quick Reference Table .....	Back Cover

## Important Messages to the Owner:

In the following paragraphs there may be some terminology that you are not familiar with. Reread this section after you familiarize yourself with your security system.

Arming Your System with Doors or Windows Open: Any sensors which are open when the system is armed will be bypassed after the exit delay has expired. This means they will not be protecting your home. If you wish to bypass a sensor after you have armed your system, you must first disarm the system, then open the door or window which you want bypassed. Your system will tell you if a protected door or window is open when you arm the system. If your system includes 24-hour protection sensors on items such as gun or jewelry cases, you must do an additional disarm called **subdisarm** before accessing these areas to avoid causing an alarm. The master access code and panic code can subdisarm. When the system is disarmed, using the Control Panel, the Remote Handheld Touchpad, or Touchtalk 2-Way RF Touchpad, enter the master access code or panic code to subdisarm the system. The Control Panel is subdisarmed when the Disarm button is flashing. If the panic code was used, an alarm will be reported to the central station.

**CAUTION!** If you use the Control Panel to arm your security system when leaving your home, you need to be aware of the following: You need to exit before the end of the delay period or an alarm will sound. Remember, when you arm you will hear 2, 3, or 4 beeps at the beginning of the exit delay (see the table "Panel Beeps" on page 3 of this manual to determine the meaning of control panel/system beeps). At the end of the exit delay, the system beeps 2, 3, or 4 additional beeps. If you exit at that time (after the exit delay), your system assumes you are now returning to your home. The system is now counting down the entry delay time and will expect you to disarm the system within the entry delay time or it will alarm.

**Something may have happened while you were away!** If you enter your home and controlled lights that are normally off are on and/or you hear alarm sirens, an intruder may be inside or another emergency may have occurred. Leave immediately, and call for non-medical emergency help.

Canceling Accidental Alarms: You have up to 120 seconds (programmable by the installer) after causing an accidental alarm to disarm your security system. See your installer to determine this amount of time. If the programmed seconds have passed, you must call the central monitoring station to cancel the alarm.

Notices for UL-Listed Installations:

- This system is suitable for Grade A household burglary applications.
- The Freeze Sensor, Glass Guard and Shock Sensors are not UL Listed.
- The garage door opening feature used with this system has not been evaluated by UL.

# Introduction to Your System

Your security system uses wireless technology to warn your family about intrusion and fire. It may also be used to control lights and appliances within your home.

The system is designed to be monitored and/or to send messages to a numeric pager.

The security system uses devices called sensors which use radio waves to communicate alarms to the Control Panel.

The system is supervised, meaning that the Control Panel checks the status of each sensor to detect problems. If the Control Panel detects trouble it will notify you with beeps and indicator lights on the Control Panel itself.

## Typical Security System Components

A typical security system installation consists of the following devices:

### Control Panel

The Control Panel is used to operate and program your security system. It communicates to you through panel voice messages, panel beeps, and by lighting buttons on the Control Panel. The Control Panel can communicate to a central monitoring station and/or a numeric pager. The Control Panel may come with 2-Way Voice On-Board.” This feature allows the Central Station to communicate with the user if there is a problem at the security system site.

### Audio Verification Module (Not for use with Basic Model)

The Audio Verification Module (AVM) gives the central station operator the ability to hear what’s happening at the premises during an alarm and speak directly to the system owner. The operator can determine how serious an alarm is, find out what kind of help is needed, and dispatch the appropriate assistance.

### Remote Handheld Touchpad and Touchtalk 2-Way RF Touchpad (Not for use with Basic Model)

These touchpads are used to control the security system primarily from within the home.

### KeyChain Touchpads

KeyChain Touchpads are used to control the security system from within or near the outside of your home.

### Indoor Motion Sensors

Indoor Motion Sensors detect motion. They may be used for intrusion protection or to sound chimes on the Control Panel.

### Outdoor Motion Sensors

Outdoor Motion Sensors detect motion in a protected outdoor area and can sound chimes or turn on outside lights. They are not used for intrusion detection.

### Door/Window Sensors

Door/Window Sensors detect the opening of a door or window.

### Smoke Sensors

Smoke Sensors detect smoke. They have a built in siren which sounds when smoke is detected.

### Modules (Not for use with Basic Model)

Modules are used to control lights, appliances, and a garage door. Only unit numbers 1-8 may be used for individual light, appliance, or garage door control.

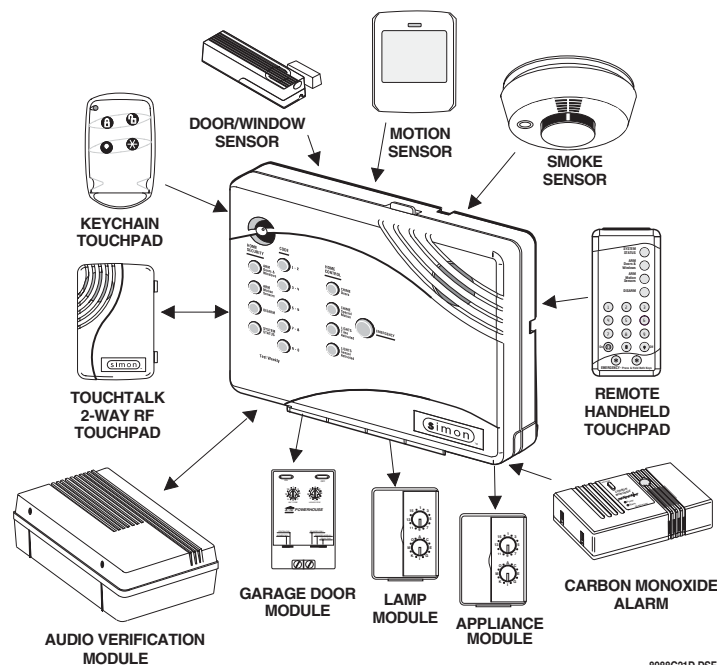

8988G21D.DSF

# Security System Beeps, Lights, and Messages

---

Your security system communicates to you through the use of panel voice messages, panel beeps, indicator lights on the panel itself, and to a numeric pager if programmed.

You communicate to your security system with key presses on the Control Panel, touchpads, or through the use of a remote telephone. Disarming and programming require you to input a 4-digit access code. **The Master Access Code default is 1-2-3-4 when the security system is shipped from the factory. You should change it to a code known only by you.**

## Panel Voice Messages

When you press the buttons on the Control Panel or the touchpads, the Control Panel responds with voice messages. Panel voice can be enabled or disabled (see "What You Can Change:" on page 9).

These messages may respond with system information or prompt you to take further action. For example, if you want to disarm the system and you press the **DISARM** button, the Control Panel responds by saying, *Please enter your access code.*

If you press a button and the feature has not been programmed into the Control Panel, the panel voice will respond with *Function not available.* An example of this situation is pressing the Control Panel button **CHIME Special Motion** when you have no non-intrusion Motion Sensors in your installation. The panel voice would respond with, *Function not available.*

## Panel Beeps

Panel beeps are used to indicate keypresses, status, and problems with the system. Panel beeps can be enabled or disabled (see "What You Can Change:" on page 9).

Use the following table to understand the beeps used by the security system.

Activity	Beep Response
ARM Doors & Windows	<b>Exit delay</b> beeps sound 2 times when you arm* and 2 times at the end of the delay time; <b>Entry delay</b> beeps sound 2 times every 5 seconds and 2 times per second during the last 10 seconds
ARM Motion Sensors	<b>Exit delay</b> beeps sound 3 times when you arm* and 3 times at the end of the delay time; <b>Entry delay</b> beeps sound 3 times every 5 seconds and 3 times per second during the last 10 seconds
ARM Doors/Windows & Motion Sensors	<b>Exit delay</b> beeps sound 4 times when you arm* and 4 times at the end of the delay time; <b>Entry delay</b> beeps sound 4 times every 5 seconds and 4 times per second during the last 10 seconds
DISARM	1 beep
CHIME DOORS	2 beeps (feature must be programmed by installer)
CHIME SPECIAL MOTION (Not Included in Basic Model)	3 beeps (feature must be programmed by installer)
Trouble Beeps	6 beeps every minute. Press SYSTEM STATUS button twice to stop beeps for 4 hours
No Activity Beeps	20 beeps every minute for 5 minutes (feature must be programmed by the installer)

\* You will not get initial exit delay beeps if you are arming from a Touchtalk 2-Way RF Touchpad.

**Note: You may receive a different number of panel beeps if buttons are pressed quickly.**

## Alarm Sirens and Lights

Exterior and interior sirens make 3 different alarm sounds on the premises, each indicating a different type of alarm. Sirens will time-out and stop sounding after the siren timeout (programmable by the installer). System controlled lights also indicate the type of alarm.

Use the following table to understand alarm sounds and controlled lights.

Alarm Type	Interior Siren Sound	Exterior Siren Sound	System Controlled Lights (Not Included in Basic Model)
Fire (Temporal 3)	3 siren pulses then off for 2 seconds, 3 siren pulses then off for 2 seconds, . . .	3 siren pulses then off for 2 seconds, 3 siren pulses then off for 2 seconds, . . .	On steady
Intrusion	On steady	On steady	Flashing
Emergency	Fast on-off	_____	On steady

## Panel Indicator Lights

Use the following table to understand the panel indicator lights.

Button	When the Button Light is On	When the Button Flashes
ARM Doors & Windows	Doors/Windows armed	Doors/Windows armed & No Entry Delay on
ARM Motion Sensors	Motion Sensors armed	Motion Sensors armed & Latchkey on
DISARM	System disarmed	System subdisarmed
SYSTEM STATUS	System trouble or Open Sensor	System in alarm
CHIME Doors	Door will cause chime	_____
CHIME Special Motion (Not Included in Basic Model)	Motion will cause chime	_____
LIGHTS Time Activated (Not Included in Basic Model)	Light schedule is on	_____
LIGHTS Sensor Activated (Not Included in Basic Model)	Sensors will cause light to go on	_____

## Numeric Pager

You may program your security system to send a numeric message indicating system activities to your pager. The system will send the message twice. See "Programming Your System" on page 9.

Use the following table to determine what the numeric message is reporting.

Reports	Numeric Message	Reports	Numeric Message
Phone Test	-101 -101	Intrusion	-108 -108
AC Power Restoral	-102 -102	Fire	-109 -109
AC Power Failure	-103 -103	Disarming	-110 -110
Latchkey	-104 -104	Arming	-111 -111
No Activity	-105 -105	Fail to Disarm	-112 -112
Panic Code	-106 -106	Fail to Arm	-113 -113
Emergency	-107 -107		



# How to Use Your Control Panel

The Control Panel interface consists of 3 columns of buttons. They are: HOME SECURITY, CODE, and HOME CONTROL. There is a non-medical EMERGENCY button located on the far right.

## HOME SECURITY

**ARM Doors & Windows.** Press once to turn the security system protection on for all protected doors and windows. If a door or window is open when you arm the system, it will be bypassed, meaning not protected. The SYSTEM STATUS light will be lit.

Press twice to eliminate the preprogrammed entry delay. The ARM Doors & Windows button blinks when **No Entry Delay** is on.

**ARM Motion Sensors.** Press once to turn protection on for all intrusion Motion Sensors. Use when no one is home. This is usually used in combination with **ARM Doors & Windows**.

Press twice to activate **Latchkey**. **Latchkey** is used to notify parents if children do not arrive home at a predetermined time and disarm the system. The ARM Motion Sensors button blinks when **Latchkey** is on.

**DISARM.** Press once and enter your access code using the **CODE** buttons to turn security protection off. Some sensors, for example smoke detectors and panic devices, are still active even when the system is disarmed.

**SYSTEM STATUS.** Press twice to hear information about your system. If the button is lit, there is a problem with the system. If the button is blinking, an alarm has occurred. Press the button to hear what is wrong with the system. See "System Tests & Trouble Beeps" on page 12. Press **SYSTEM STATUS** then the **7 - 8** button to turn all lights on. Press **SYSTEM STATUS** then the **9 - 0** button to turn all lights off. (**Not for use with Basic Model**)

## CODE

There are 5 **CODE** buttons located on the left side of the Control Panel. Each button represents 2 numbers. The top **CODE** button is **1 - 2** which means that this button is pressed when entering either 1 or 2. For example, if your access code is **1-2-3-4** you must press the **1 - 2** button twice and the **3 - 4** button twice.

If your system includes 24-hour protection sensors on items such as gun or jewelry cases, you must subdisarm the Control Panel before accessing these areas to avoid causing an alarm. To subdisarm the system when it is already disarmed, enter the master access code. The **DISARM** button will flash when the Control Panel is subdisarmed.

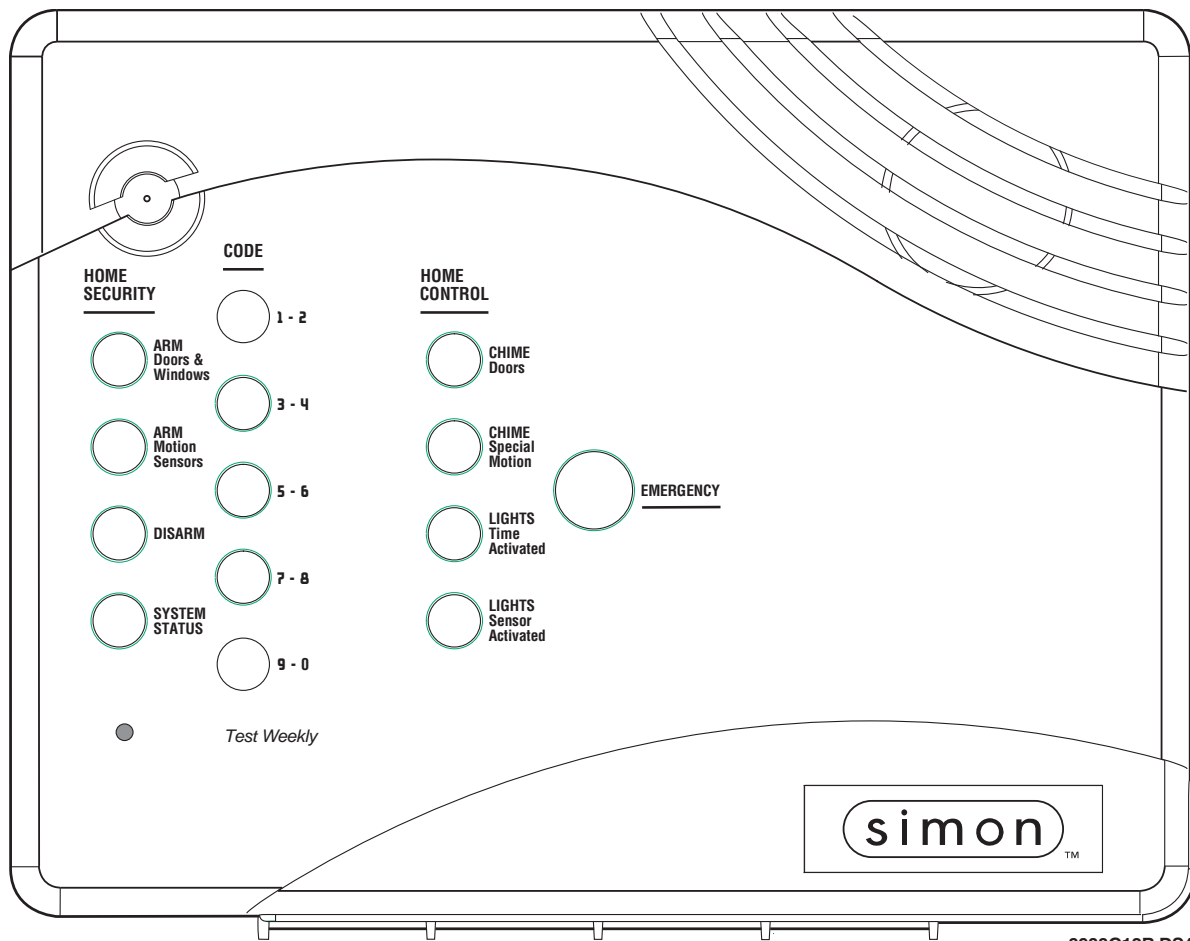

8988G12B.DS4

## HOME CONTROL

If any of the HOME CONTROL buttons are pressed and a sensor or module is not associated (programmed) with this feature the Control Panel will say, *Function not available*.

**CHIME Doors.** Press to cause the Control Panel to beep when protected doors or windows are opened.

This is a nice feature to use if you're busy in one part of your home and you want to know when family members are going in and out of your home.

**CHIME Special Motion. (Not Included in Basic Model)**

Press to cause the Control Panel to beep when Motion Sensors detect movement within a specific area. These Motion Sensors are not used for intrusion protection.

If you have Motion Sensors located in areas such as in a patio area or at the front door and you want to know when someone is approaching these areas, you would use this feature.

**LIGHTS Time Activated. (Not Included in Basic Model)**

Press to enable system controlled lights to turn on and off at scheduled times.

An example is turning your living room lights on at 7 pm and off at 10 pm.

**LIGHTS Sensor Activated. (Not Included in Basic Model)**

Press to have specially programmed sensors turn on lights for 4 minutes when sensors are tripped.

An example is using an outdoor Motion Sensor at the front door. When the Motion Sensor detects movement it will cause the light at the front door to turn on.

You may also program the star button on the KeyChain Touchpad to turn on a light for 4 minutes. The KeyChain Touchpad star key will always work, even when sensor activated lights are disabled.

## EMERGENCY

Press **EMERGENCY** for 2 seconds or twice quickly to call the central monitoring station and notify them of a non-medical call for help.

If the decal pictured below (shown in gray) is on your panel, you can press the EMERGENCY button then one of the other 3 buttons (intrusion, auxiliary, or fire) to call the central monitoring station or a numeric pager.

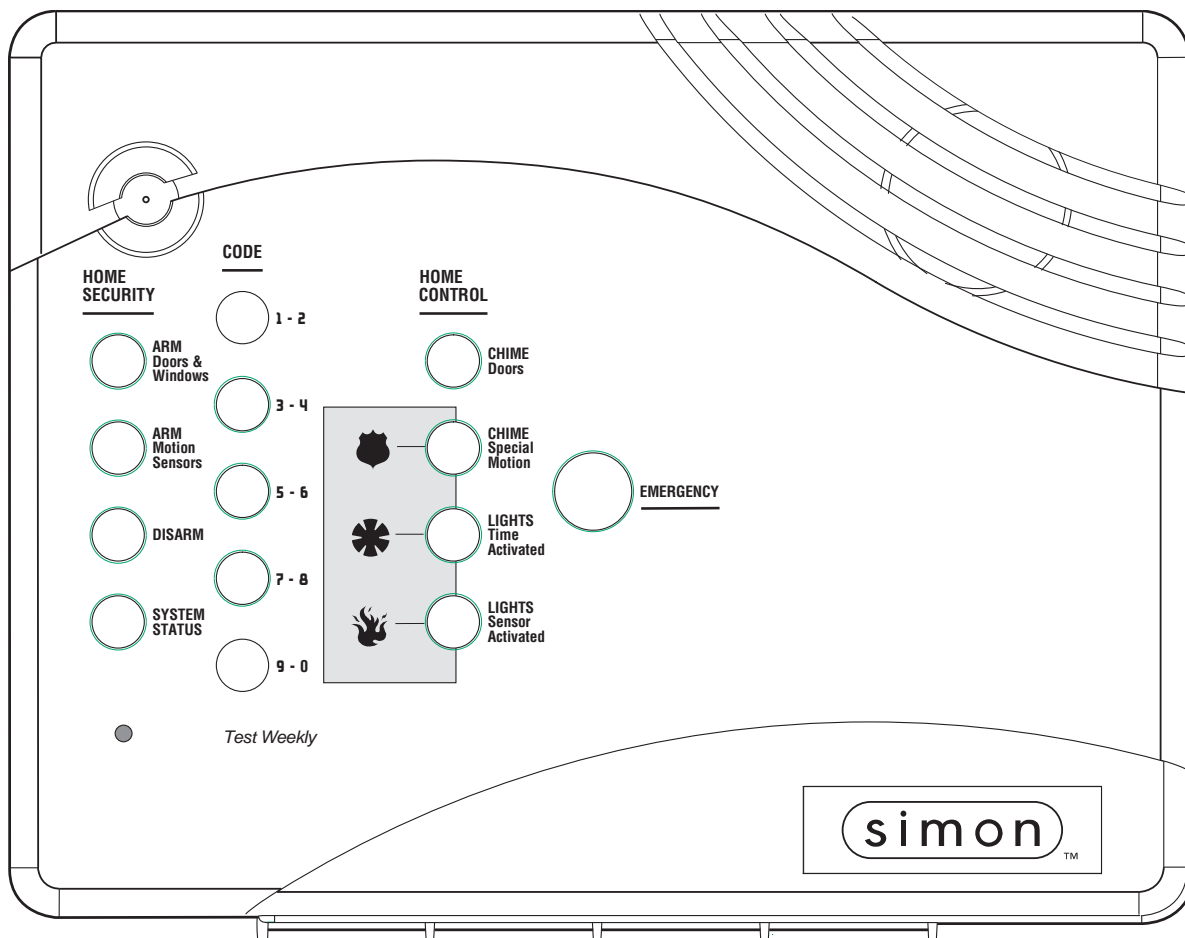

8988G12C.DS4

# How to Use An Off-Site Phone for Remote Phone Control (Not Included in Basic Model)

You may use an off-site phone to arm/disarm your Control Panel, toggle lights, check system status, or conduct an audio session (ask your installer if you have this feature). To gain access to the Control Panel:

1. Call the Control Panel and let the phone ring twice then hang up.
2. Wait at least 10 seconds and call the Control Panel again. You may wait up to 40 seconds before calling again.
3. The Control Panel should answer on the first ring. You won't hear any prompt when the system answers.
4. Press the \* button on your telephone and you will hear *system activated*.

At this point you may perform the actions listed in the first paragraph of this page.

For example, to check system status:

Press \* + CODE + # + 1 on your telephone. CODE is any access code programmed into your Control Panel.

**Note: Press \* + CODE + 9 to hang up or your security system site phone may be busy for up to 90 seconds after your disconnect.**

**Note:** If you are interactive with your Control Panel and the panel hangs up on you, the system is calling in a report to the central monitoring station or a pager, due to an action made by you or someone at the security system site.

The following table identifies the phone commands to be used when using remote phone control.

**Phone Commands for Remote Access**

Control Panel Function	Phone Command
DISARM	* + CODE + 1
ARM Doors/Windows	* + CODE + 2
ARM Doors/Windows with No Entry Delay	* + CODE + 2 + 2
ARM Motions	* + CODE + 3
ARM Motions with Latchkey	* + CODE + 3 + 3
ARM Doors/Windows and Motions	* + CODE + 2 + 3
ARM Doors/Windows with No Entry Delay and Motions with Latchkey	* + CODE + 2 + 2 + 3 + 3
Toggle Lights	* + CODE + 0
System Status	* + CODE + # + 1
Audio Session	* + CODE + 5 + X (X = a command from the audio session command set). See Table on page 7
Hang Up	* + CODE + 9

CODE = any access code

## 2-Way Voice Audio Session (Not Included in Basic Model)

An audio session may be conducted from off site. You can call the security system site and talk to the people present and they can talk to you using the speaker and microphone on the Control Panel.

**Note: Ask your installer if you have this feature available to you.**

Do the following to conduct an audio session:

1. Follow the instructions above for Remote Phone Control to gain access to the Control Panel.
2. Press \* + CODE + 5 on the phone to start the audio session.
3. Press 1 to speak or 3 to listen.  
If you press 3 to listen you may notice a 5 second delay before you can hear the Control Panel's surroundings. See the following table **Audio Session Command Set** for the commands that can be used from an off site phone.
4. Press 9 + 9 to hang up.

**Audio Session Command Set**

Phone Button(s)	Audio Session
1	Speak
3 or 6	Listen
7	Extends the session for 90 more seconds
99	Terminates session

**Note:** If 1, 3, 6, or 7 is pressed, the session time is extended for 90 more seconds. The panel will sound time out warning beeps when there are 20 and 10 seconds left of the session.

# How to Use Your Touchpads

Touchpads are used to control the security system from any location within or near your home. They have additional home control features such as light and appliance control. When using the Touchtalk 2-Way RF Touchpad, beeps and voice feedback will be heard from this touchpad and not from the Control Panel.

## Remote Handheld Touchpad and Touchtalk 2-Way RF Touchpad (Not for use with Basic Model)

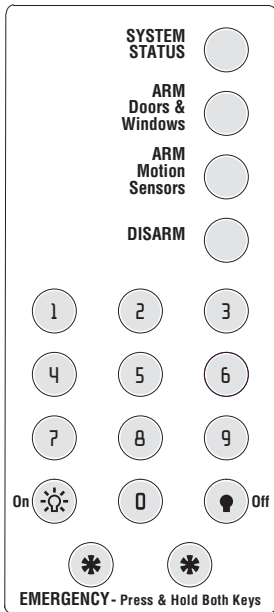

8988G07B.DS4

**SYSTEM STATUS** Press once to hear information about your system. See “System Tests & Trouble Beeps” on page 12.

**ARM Doors & Windows** Press once to turn the security system protection on for all protected doors and windows. Press twice to eliminate the preprogrammed entry delay.

**ARM Motion Sensors** Press once to turn protection on for all Motion Sensors. Use when no one is home. This is usually used in combination with ARM Doors & Windows. Press twice to activate the Latchkey feature.

**DISARM** Press once and enter your access code using the NUMERIC buttons to turn security protection off. To subdisarm the system, enter the master access code.

**ON Light button** Press twice quickly to activate all lights controlled by the security system. You may turn on specific lights and appliances by pressing this button once and entering the unit number of a light or appliance using the NUMERIC buttons.

**OFF Light button** Press twice quickly to turn off all lights. You may turn off specific lights and appliances by pressing this button once and entering the unit number of the light or appliance.

**EMERGENCY** Press both **EMERGENCY** buttons for 3 seconds to cause the system to call a central monitoring station to report a non-medical emergency.

## KeyChain Touchpad

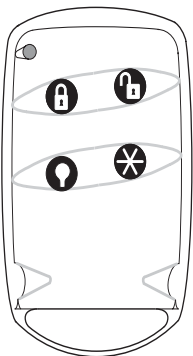

**LOCK** Press once to arm doors and windows.

**LOCK** Press twice to arm doors, windows, and Motion Sensors.

**LOCK** Press 3 times to arm doors, windows, Motion Sensors, and to activate the Latchkey option.

Entering your home If your installer programmed the KeyChain Touchpad with no entry delay, and you armed the system with the KeyChain Touchpad, you must disarm your system from outside of the home to avoid causing an alarm.

Exiting your home You have at least 5 seconds and up to 120 seconds (depending on installer programming) to leave without causing an alarm.



**LOCK and UNLOCK** Press both buttons simultaneously for 3 seconds to send an intrusion, silent, or non-medical emergency alarm to the central monitoring station.



**UNLOCK** Press to disarm your security system.



**LIGHT** Press to turn system controlled lights on or off.



**STAR** Press to open or close your garage door, if programmed, or your system may be programmed to turn on a light using this button.

**For any keypress on the KeyChain Touchpad, hold the button until the indicator light blinks.**

# Programming Your System

---

## What You Can Change:

### Options:

Press **Add** in the **START MENU** and follow the voice prompts to turn an option on.

Press **Delete** in the **START MENU** to turn an option off.

#### Option 01 - Panel Beeps

Panel Beeps are any beeps (including chime beeps) that come from the Control Panel. Panel Beeps, except for alarm sirens, may be disabled. See "Panel Beeps" on page 3.

#### Option 02 - Panel Voice

Panel Voice may be disabled, except for status messages, open sensor responses, and when in program mode.

#### Option 03 - Latchkey Time

Adding this option allows you to program Latchkey Time. Latchkey is used to notify parents if children do not arrive home at a predetermined time and disarm the system.

#### Option 36 - Sensor Activated Light Lockout Start Time

#### Option 37 - Sensor Activated Light Lockout Stop Time (Not for use with Basic Model)

The Control Panel will not turn on a light which is activated by a sensor, even if sensor activated lights are enabled, between the programmed start time (option 36) and the programmed stop time (option 37).

Both options must be programmed for this feature to work. The **LIGHTS Sensor Activated** button must be lit for lights to turn on.

#### Option 41 - Voice Chime

The Control Panel will verbally announce which chime sensor has been tripped if the chime feature is on.

#### Option 42 - Speaker Level (Not for use with Basic Model)

Turn the Control Panel speaker level to the high voice level when the option is turned on or turn the speaker level to the low voice level when turned off.

#### Option 43 - Pager Phone Number

Up to 22 digits, including pauses, may be programmed for the pager phone number.

Add 3 or 4 pauses to the end of the phone number to ensure the complete pager message will be received.

Press the **Test** button to program a pause into the phone number.

#### The Control Panel will call the pager to indicate:

- **No activity** - The no activity time period is programmed by your installer. A no activity alarm is called in if the programmed amount of time passes, the Control Panel is subdisarmed, disarmed, or doors and windows armed, and no activity has occurred (a key has not been pressed or a sensor has not been tripped). Tripping of non-intrusion chime sensors is not considered activity.
- **Latchkey** - A latchkey report is called when the system

is not disarmed by a predetermined time. The latchkey time is programmed by the user - Option 03. Latchkey must be enabled when arming.

- **Phone Test** - A phone test report is called in when a phone test has been performed.
- **Disarming** - A disarming report is called in when the system is disarmed. This option is programmed by your installer.
- **Arming** - An arming report is called in when the system is armed. This option is programmed by your installer.
- **Fail to Disarm** - A fail to disarm report is called in when the system is not disarmed by the time programmed by the installer.
- **Fail to Arm** - A fail to arm report is called in when the system is not armed by the time programmed by the installer.
- **AC Power Failures** - An AC power failure is called in 15 minutes after loss of power.
- **AC Power Restoral** - A restoral will be reported when power is restored.
- **Alarms** - Alarm reports include: Emergency, Intrusion, and Fire.

**Sensor Test or Phone Test** . A sensor test or phone test can be performed by following the instructions given in the section labeled "Manual Tests--What You Need to Test" on page 13 of this manual.

**Access Codes.** Your security system has a master access code, access codes 1-5, and a panic code. The master code is used for disarming and programming your system. Access codes 1-5 are generally used for children or as temporary codes for a babysitter or service personnel and may be used only for disarming. The panic code may be entered to disarm or subdisarm the system in a non-medical emergency situation. The Control Panel will call the central station, but there will be no indication of an alarm at the Control Panel.

**Note:** Because different codes can be entered using the same button presses you have to use caution when programming the panic code. You need to ensure that the panic code does not use the same button presses as other access codes. For example if the master code is 1234, do not program the panic code to be 2244. The Control Panel would interpret these codes to be the same code.

**Time Activated Lights. (Not Included in Basic Model)** Lights may be put on a time schedule.

**Entry/Exit Activated Lights. (Not Included in Basic Model)** Lights will turn on for the delay period.

**Sensor Activated Lights. (Not Included in Basic Model)** Lights will turn on for 4 minutes after a sensor is tripped.

**Set Clock.** If the panel loses power, the clock must be set.

**House Code. (Not Included in Basic Model)** The house code programmed into the panel should match the house code set on lamp, appliance, and garage door modules.

# Programming Using Panel Decals (Upper Decal and Lower Decal) (Not Included in Basic Model)

The programming decals are visible when you open the Control Panel cover. These decals are designed to make system programming easier for you. Always begin by choosing a button from the **START MENU**. Follow the voice prompts and flow arrows to complete the desired task. Notice the button flow diagrams under **Instruction Summary** to the right of the buttons and on the lower decal.

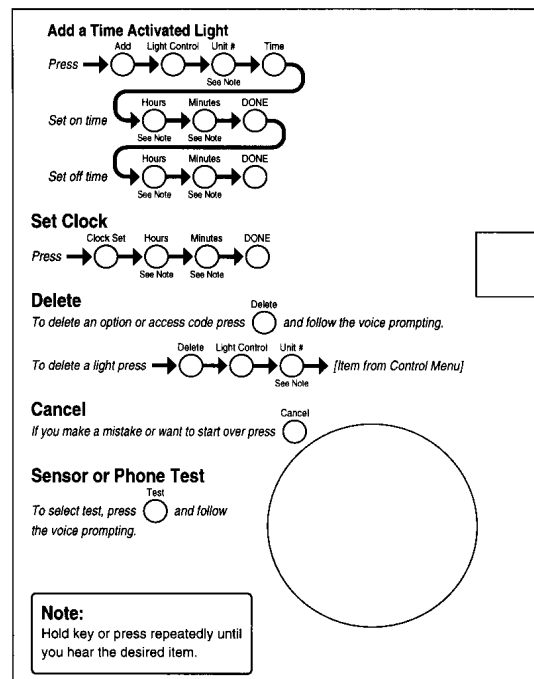
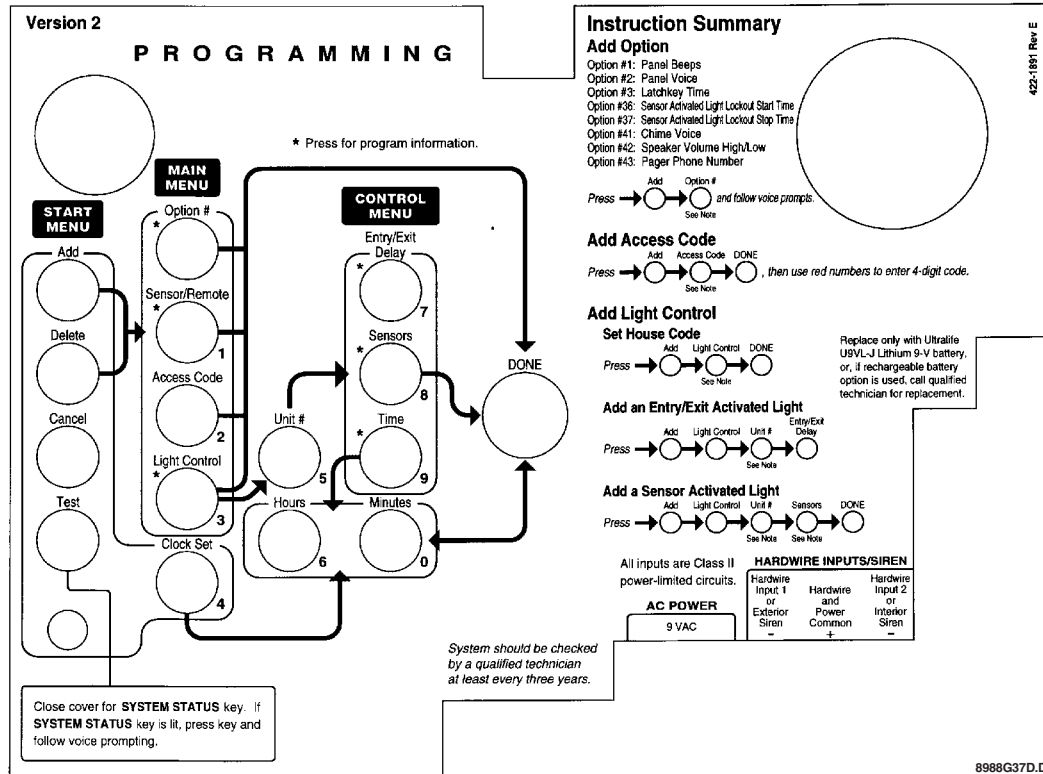

# Step by Step Programming Instructions

Use the following instructions to access the programming buttons and programming decals.

1. **Open the Control Panel Cover** by pressing the plastic latch on the top of the Control Panel.  
When you open the cover you will immediately be prompted by the Control Panel voice to use the red numbered keys to enter your ID.
2. **Enter Your Access Code.**

**The Master access code is 1-2-3-4 when the panel is shipped. You should change it to a code known only by you.**

3. The system voice will prompt you to begin with the **START MENU**. The **START MENU** is located on the left side of the upper decal.

The **START MENU** includes the following buttons:

- Add
- Delete
- Cancel
- Test
- Clock Set

**Press the appropriate button.**

4. After pressing a button on the **START MENU** the system voice will prompt you to then **use the MAIN MENU**.

The **MAIN MENU** includes the following buttons:

- Option #
- Sensor/Remote
- Access Code
- Light Control

**Press the appropriate button.**

Depending on the button you pressed, the system will prompt you to continue by pressing other buttons on the panel.

## How to Change an Access Code

1. **Open the cover** of the Control Panel.
2. The panel voice prompts you to *Use red numbered keys to enter 4-digit ID*. **Enter your master access code** using the red numbered keys.
3. The panel voice prompts you to *Please select from START MENU*. **Press the Add button** on the START MENU.
4. The panel voice prompts you to *Select from MAIN MENU*. **Press the Access Code button** on the MAIN MENU.
5. The panel voice responds with *Master Code, press again for next access code or DONE to select or CANCEL to quit*. Press the access code button again to hear the next access code. When you hear the access code you wish to change **press the DONE Button**.
6. **Enter 4 new numbers** using the red numbered keys.

7. **Close the Control Panel cover.**

## Add Access Code

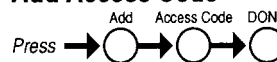
Press →  , then use number keys to enter code

## How to Delete an Access Code

1. **Open the cover** of the Control Panel.
2. The panel voice prompts you to *Use red numbered keys to enter 4-digit ID*. **Enter your master access code** using the red numbered keys.
3. The panel voice prompts you to *Please select from START MENU*. **Press the Delete button** on the START MENU.
4. The panel voice prompts you to *Select from MAIN MENU*. **Press the Access Code button** on the MAIN MENU.
5. The panel voice responds with *Access Code 1, press again for next access code or DONE to select or CANCEL to quit*. Press the access code button again to hear the next access code. When you hear the access code you wish to delete, **press the DONE Button**. The panel voice responds with **Access Code X deleted**.
6. **Close the Control Panel cover.**

## Delete Access Code

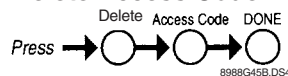
Press →  8988G45B.DS4

## Options

The following is a table of options you can change. See “What You Can Change:” on page 9 for a description of these options.

Option #	Add	Delete
1 - Panel Beeps	On	Off
2 - Panel Voice	On	Off
3 - Latchkey Time	12am - 11:59 pm	Off
36 - Sensor Activated Light Lockout Start Time (Not for use with Basic Model)	12am - 11:59 pm	Off
37 - Sensor Activated Light Lockout Stop Time (Not for use with Basic Model)	12am - 11:59 pm	Off
41 - Chime Voice	On	Off
42 - Speaker Volume High/Low (Not for use with Basic Model)	High	Low
43 - Pager Phone Number	Up to 22 digits*	Off

\* See “Option 43 - Pager Phone Number” on page 9

# System Tests & Trouble Beeps

---

## Automatic Control Panel Testing--What the System Tests for You

Your security system is able to automatically test itself for:

- Power failures
- Low batteries
- Non-working sensors
- Communication troubles with the Central Monitoring Station

**Trouble Beeps.** When your security system detects one of the problems above, interior sirens sound trouble beeps rapidly six times, and then again every minute, until the trouble condition is corrected.

If you do a status check by pressing the **SYSTEM STATUS** button twice or change the system from being armed to disarmed or disarmed to armed, the beeps will stop. If the problem is not corrected, beeps start again 4 hours later.

### Silencing Trouble Beeps

Pressing the **SYSTEM STATUS** button twice or changing from armed to disarmed or disarmed to armed while the system has a trouble condition stops the trouble beeps. Trouble beeps begin again 4 hours later, in some cases, unless the trouble condition is corrected.

**AC Power Failure.** This condition occurs if your security system has been accidentally unplugged or if there has been an AC power outage. The backup battery will take over. If AC power is not restored within 15 seconds, the Control Panel will go dark and alert you with trouble beeps. If you press any button, the display will light and pressing **SYSTEM STATUS** twice will confirm the AC power failure. If AC power is not restored within 15 minutes, the system will call the central monitoring station (if programmed by installer). The backup battery, if fully charged, will last for 18 - 24 hours with no AC power.

**System Battery Failure.** This condition occurs if the emergency backup battery has been drained. Trouble beeps will start and the **SYSTEM STATUS** button will light. Press the **SYSTEM STATUS** button twice to hear the trouble message. If your AC power is not working, your security system will shut down once the battery is drained. The Control Panel battery should be replaced once a year if using a 9V Ultralife battery.

**Sensor Failure.** This condition occurs if a sensor is not communicating with the Control Panel. Trouble beeps will start and the **SYSTEM STATUS** button will light. Press the **SYSTEM STATUS** button twice to hear which sensor(s) have trouble. Perform sensor tests. It may be necessary for you to

call your security system dealer if the problem continues.

**Sensor Low Battery.** This condition occurs if a system sensor has a low battery. The sensor may still be communicating with the Control Panel. Trouble beeps will start and the **SYSTEM STATUS** button will light. Press the **SYSTEM STATUS** button twice to hear which sensor(s) have trouble. It may be necessary for you to call your security system dealer to resolve this problem. Some sensor batteries can be replaced by the homeowner.

**Fail-To-Communicate.** This condition occurs if your security system cannot communicate to the central monitoring station. Your system will try to report to the central monitoring station 8 times before it tells you there is a Fail-To-Communicate problem. Trouble beeps will start and the **SYSTEM STATUS** button will light. Press the **SYSTEM STATUS** button twice to hear the trouble message. It may be necessary for you to call your security system dealer if the problem continues.

**Sensor Open.** This condition occurs if a door or window is open, or a system sensor has been disturbed or tampered and not reset properly. For example, a Motion Sensor may be off the wall or a Door/Window Sensor cover may have been removed from the sensor. Your system will indicate this condition to you by causing the **SYSTEM STATUS** button to light. When you press this button twice, the system responds with *Sensor # Name open*. Correct the problem by resetting the sensor. If this condition continues call your security system dealer

**Option 50 Detected.** The Control Panel receiver may be experiencing some interference. The system will call to notify the central monitoring station about this problem.

**Module 1 or 2 Failure.** Call your security system dealer.

**System Access Alarm.** The Control Panel cover was opened while the system was armed. The system will call the central monitoring station to report a tamper alarm.

### Clearing System Status

If a trouble condition is corrected, press the **SYSTEM STATUS** button twice, listen to the status message, then disarm the system to clear system status. If the trouble condition was a low CPU battery, perform a sensor test. The **SYSTEM STATUS** button should turn off if all trouble conditions have been corrected.



## Manual Tests--What You Need to Test

As an added safeguard, there are system tests you should do yourself on a regular basis. The Control Panel cover in the lower left corner reminds you to **TEST WEEKLY**.

### Sensors

You can test sensors one at a time to make sure they are sending strong signals to the Control Panel (see Testing Sensors paragraph).

### Communication

You can also test the communication between your system and the Central Monitoring Station (see Testing Communication paragraph).

### Testing Sensors

You should test the security system at least once each week.

To perform the sensor test:

1. Open the Control Panel Cover.
2. Enter the master access code.
3. Press the **Test** button once, the Control Panel will say *Sensor Test*.
4. Press the **DONE** button.

The panel will voice prompt you with a list of your programmed sensors that you need to test. The panel will start with sensor 1 and say *Test sensor 1, sensor name*.

When you trip a sensor and it communicates successfully it will be removed from the list. You may trip the sensors in any order. The sensor test has a 4 minute time out that resets with each sensor trip.

After all sensors have been successfully tested, the Control Panel will say *Sensor test complete, press DONE*. Press **DONE**. The Control Panel will say *Sensor test ok*.

If any of the sensors did not test successfully and you want to terminate the test, **press DONE**. The Control Panel will say *Sensor test canceled or failure*. If a sensor test fails, call your security dealer.

Use the following table to trip sensors.

### Sensor Tripping Instructions:

Sensor	Do This
Door/Window	Open the secured door or window
Freeze	Apply ice to the sensor. Do not allow the sensor to get wet
Water	Press a wet rag or wet finger over both of the round, gold-plated terminals on the underside of the sensor
Carbon Monoxide Alarm	Unplug the CO Alarm. Plug it back in, then press the TEST/RESET button until the unit beeps 8 times

### Sensor Tripping Instructions:

Sensor	Do This
Glass Guard	Tap the glass 3 or 4 inches from the sensor
Motion Sensor	Avoid the Motion Sensor's view for 5 minutes, then enter its view
Rate-of-Rise Heat Detector	Rub your hands together until warm, then place one hand on the detector for 30 seconds
Shock	Tap the glass twice, away from the sensor. Wait at least 30 seconds before testing again
Smoke	Press and hold the test button until the system sounds transmission beeps
Panic Buttons	Press and hold the appropriate panic button(s) for 3 seconds
KeyChain Touchpad	Press and hold LOCK and UNLOCK simultaneously for 3 seconds
Remote Handheld Touchpad and Touchtalk 2-Way RF Touchpad (Not for use with Basic Model)	Press and hold the 2 EMERGENCY buttons simultaneously for 3 seconds
SWS (Not for use with Basic Model)	Unplug the SWS, plug the unit back in

### Testing Communication

Test communication with your central monitoring station and the pager at least once per week to make sure you have the proper telephone connection between your system and the central monitoring station.

To perform a phone test:

1. Open the Control Panel cover.
2. Enter the master access code.
3. Press the **Test** button twice, the Control Panel will say *Phone Test*.
4. Press the **DONE** button.

The Control Panel will say *Phone test is on twice*. If the test is successful the Control Panel will say *Phone test ok* within 3 minutes. The Control Panel will say *Phone test is on* three times if you have a pager. Your pager will display 101 101 if the phone test to the pager was successful. If the test is unsuccessful, the **SYSTEM STATUS** button will light and the Control Panel will say *Phone communication failure* within 10 minutes. If a phone test fails, call your security system dealer.

**NOTE: If your system is not connected to a central monitoring station, and you don't use a pager, you won't be able to perform the phone test.**

# Your Emergency Evacuation Floor Plan

---

## Planning for Emergencies

This section describes what you can do to plan ahead for an emergency:

- Emergency Planning
- Your Floor Plan

### Emergency Planning

Since an emergency is always unexpected, you should develop plans to help prepare for a variety of emergency situations. Periodically discuss and rehearse emergency plans to include the following:

- Understand how to use your security system
- Know the normal state of doors and windows; open, closed, or locked.
- Escape fast! (Do not stop to pack.)
- Use a different escape route if closed doors feel hot to the touch.
- Crawl and hold your breath as much as possible to help

reduce smoke inhalation during your escape.

- Meet at a designated outdoor location.
- Emphasize that no one should return to the premises if there is a fire.
- Notify the fire department from a neighbor's phone.
- Emphasize that no one should enter the premises if they hear sirens in the house.
- If you arrive at the premises and hear sirens, do not enter. Call for emergency assistance from a neighbor's phone.

### Your Floor Plan

Use the following guidelines when drawing your floor plan:

- Show all building levels.
- Show exits from each room (two exits per room are recommended).
- Show the location of all security system components.
- Show the location of any fire extinguishers.



# Alarm System Limitations

---

Not even the most advanced alarm system can guarantee protection against burglary, fire, or environmental problems.

All alarm systems are subject to possible compromise or failure-to-warn for a variety of reasons.

- If sirens are not placed within hearing range of persons sleeping or in remote parts of the premises, or if they are placed behind doors or other obstacles.
- If intruders gain access through unprotected points of entry or areas where sensors have been bypassed.
- If intruders have the technical means of bypassing, jamming, or disconnecting all or part of the system.
- If power to sensors is inadequate or disconnected.
- If freeze or any environmental sensors are not located in areas where the appropriate condition can be detected.
- If smoke does not reach a Smoke Sensor. For example, Smoke Sensors cannot detect smoke in chimneys, walls, roofs, or smoke blocked by a closed door. Sensors may not detect smoke in other levels of the building. Sensors may not warn in time when fires are caused by smoking in bed, explosions, improper storage of flammables, overloaded electrical circuits, or other hazardous conditions.
- If telephone lines are out of service. Telephone lines are also vulnerable to compromise by any of several means.

Inadequate maintenance is the most common cause of alarm failure. Therefore, test your system at least once per week to be sure sensors, sirens, and phone communications are all working correctly.

Although having an alarm system may make you eligible for reduced insurance premiums, the system is no substitute for insurance.

**WARNING!** Security system devices cannot compensate you for the loss of life or property.

## Service

If you have any questions about your security system or if you ever need service, please contact your security consultant.

Company Name \_\_\_\_\_

Phone Number \_\_\_\_\_

Address \_\_\_\_\_

\_\_\_\_\_

















Numerics  
 2-Way Voice Audio Session 9  
 2-Way Voice On-Board 4  
 A  
 AC Power Failure 11, 14  
 AC Power Restoral 11  
 Access Code, change 13  
 Access Code, delete 13  
 Access Codes 11  
 Alarm 6  
 Alarm Sirens and Lights 6  
 Alarm System Limitations 19  
 Alarm Type 6  
 Alarms 11  
 ARM Doors/Windows 5, 7, 9, 10  
 ARM Doors/Windows & Motion Sensors 5, 9  
 ARM Doors/Windows with No Entry Delay 9  
 ARM Doors/Windows with No Entry Delay and Motions  
 with Latchkey 9  
 ARM Motion Sensors 5, 7, 9, 10  
 ARM Motions with Latchkey 9  
 Arm with Doors or Windows Open 3  
 Arming 11  
 audio session 9  
 Audio Verification Module 4  
 Audio Verification Set 9  
 B  
 battery failure 14  
 Beeps 5, 14  
 C  
 Canceling Accidental Alarms 3  
 Change an Access Code 13  
 CHIME Doors 5, 8  
 CHIME Special Motion 5, 8  
 Clearing System Status 14  
 CODE 7  
 Communication test 15  
 Control Panel 4  
 D  
 delay, entry 5  
 delay, exit 5  
 Delete an Access Code 13  
 DISARM 5, 7, 9, 10  
 Disarm 11  
 Door/Window Sensors 4  
 E  
 Emergency 6, 8, 10  
 Emergency Evacuation Floor Plan 18  
 Entry delay 5  
 Entry/Exit Activated Lights 11  
 Exit delay 5  
 F  
 Fail to Arm 6, 11  
 Fail to Disarm 6, 11  
 Fail-To-Communicate 14  
 Fire (Temporal 3) 6  
 H  
 HOME CONTROL 8  
 HOME SECURITY 7  
 House Code 11  
 I  
 Indoor Motion Sensors 4  
 Intrusion 6  
 K  
 KeyChain Touchpad 10  
 KeyChain Touchpads 4  
 L  
 Latchkey 7, 9, 11  
 Light 10  
 Light button 10  
 Light Lockout 11  
 LIGHT ON/OFF 10  
 light unit number 10  
 light unit numbers 4  
 lights on/off 7  
 LIGHTS Sensor Activated 8, 11  
 LIGHTS Time Activated 8  
 Lights Time Activated 11  
 limitations 19  
 LOCK 10  
 M  
 Master Access Code default 5  
 Messages to the Owner 3  
 messages, trouble 14  
 Module 1 or 2 Failure 14  
 Modules 4  
 motion sensors 4, 5, 6, 7, 9  
 N  
 No activity 11  
 No Activity Beeps 5  
 No Entry Delay 7  
 O  
 Option 01 - Panel Beeps 11  
 Option 02 - Panel Voice 11  
 Option 03 - Latchkey Time 11  
 Option 36 - Sensor Activated Light Lockout Start Time  
 11  
 Option 37 - Motion Activated Light Lockout Stop Time  
 11  
 Option 41 - Voice Chime 11  
 Option 42 - Speaker Level 11  
 Option 43 - Pager Phone Number 11  
 Option 50 Detected. 14  
 Option Table 13  
 Outdoor Motion Sensors 4  
 P  
 pager 6  
 pager reports 6, 11  
 Panel Beeps 5  
 Panel Indicator Lights 6  
 Panel Voice Messages 5  
 panic code 3  
 Phone Commands for Remote Access 9

Phone Test 11, 15  
Programming Decals 12  
Programming Instructions 13  
R  
Remote Access 9  
Remote Handheld Touchpad 10  
Remote Handheld Touchpad and Touchtalk 2-Way RF  
Touchpad 4  
Reports, pager 6  
S  
Sensor Activated Lights 8, 11  
Sensor Failure 14  
Sensor Low Battery 14  
Sensor Open 14  
Sensor Test 11  
sensor testing 15  
Sensor Tripping Instructions 15  
Sensors 4, 15  
Service 19  
Set Clock 11  
Silencing Trouble Beeps 14  
Sirens 6  
Smoke Sensors 4  
STAR 10  
subdisarm 3, 7  
System Access Alarm 14  
System Battery Failure 14  
SYSTEM STATUS 6, 7, 10, 14  
System Status 9  
SYSTEM STATUS, clearing 14  
System Tests 14, 15  
T  
Table Alarm Type 6  
Table Audio Verification Set 9  
Table Numeric Pager 6  
TABLE OF CONTENTS 3  
Table Options 13  
Table Panel Beeps 5  
Table Panel Indicator Lights 6  
Table Phone Commands for Remote Access 9  
Table Sensor Tripping Instructions 15  
test phone 15  
Testing Communication 15  
Testing Sensors 11, 15  
Time Activated Lights 8, 11  
Toggle Lights 9  
touchpads 10  
Touchtalk 2-Way RF Touchpad 10  
Trouble Beeps 5, 14  
trouble beeps, silencing 14  
Trouble Messages 14  
U  
unit numbers 4  
UNLOCK 10





## Quick Reference Table

How to . . .	CONTROL PANEL	REMOTE HANDHELD & Touchtalk 2-Way RF TOUCHPAD	KEYCHAIN TOUCHPAD	REMOTE PHONE CONTROL
Arm the system – Doors & Windows	ARM Doors & Windows	ARM Doors & Windows		Press * + Master Code + 2
Arm the system – Motion Sensors	ARM Motion Sensors	ARM Motion Sensors		Press * + Master Code + 3
Arm the system – Doors/Windows & Motion Sensors	ARM Doors & Windows ARM Motion Sensors	ARM Doors & Windows ARM Motion Sensors		Press * + Master Code + 2 + 3
Activate No Entry Delay	ARM Doors & Windows	ARM Doors & Windows		Press * + Master Code + 2 + 2
Activate the Latchkey feature	ARM Motion Sensors	ARM Motion Sensors		Press * + Master Code + 3 + 3
Disarm the system	DISARM	DISARM		Press * + Master Code + 1
Subdisarm the system	Master Code	Master Code		Press * + Master Code + 1
Send an alarm to the Central Monitoring Station	EMERGENCY	  Press both EMERGENCY buttons. Press & hold for 3 seconds.	  Press & hold for 3 seconds	Press * + Master Code + # + 1
Check the system status	SYSTEM STATUS	SYSTEM STATUS		Press * + Master Code + # + 1
Set doors to Chime	CHIME DOORS			
Set Special Motion Chime	CHIME Special Motion			
Set lights to time activated	LIGHTS Time Activated			
Set lights to sensor activated	LIGHTS Sensor Activated			
Open a garage door or turn on special lights		 + Unit #		
Toggle lights	Lights on			Press * + Master Code + 0
	Lights off			Press * + Master Code + 0